



MAS Solar

Switch To Green Energy

Company

Introduction



MAS Solar Systems Limited was established in AUGUST 2010 in the well-equipped Industrial Estate in Coimbatore which is Manchester of South India. MAS Solar Systems Limited started to focus completely on Solar Energy and its applications.

MAS Solar Systems Limited is one of the Solar PV Modules Manufacturers in India. We provide solutions for power related to various Industries, Institutions, Domestic & Commercial purpose. We also tie- up with Renewable Research Institutions & Industries for Product development, Testing & Certifications, Training and Awareness program.

MAS Solar Systems Limited has gained a well revered name in the domain of solar equipments. We are one of the leading manufacturer, supplier of hi-tech solar products in the market with the strong Research & Development team. The company has planned to introduce various solar products to the nation in “motto to support use of solar energy” by giving the quality solar products. The company MAS was incorporated in the year 2010 at Coimbatore.

Our Vision, Mission, Goal



Vision

Deliver renewable energy solutions that delight customers and create shareholder value.



Mission

Become a world class solar energy manufacturer and solutions provider with affordable prices globally



Goal

Aim to lead the solar power industry and achieve ₹10000 crore turnovers with 500 happy employees and 500 satisfied Customers by 2030

Director

Keynote



Since inception from the year 2010 MAS Solar System is fully committed to emerge pioneer in solar products. We have seen very steady growth years except Covid 19 period and it reminds me that how we have maneuvered those situation to sustain our business .I am really proud to be having candid attitude employees, elite customers, noble supply partners and encouraging directors during difficult time. Currently we have expanded our business largely in Megawatt Ground Mounted portfolio to achieve our ambitious growth plan before the year 2025. With all your support and blessings of our esteemed customers, Mas Solar will achieve these target easily.

Anbazhagan. P
Managing Director

Board Of Director's



K. Suganthi
Whole Time Director



Dr. Visagamoorthy
Independent
Director



R. Vincent Jeyaraj
Independent
Director

Key Person's



Arjunan

Company Secretary



Senthilkumar

**Deputy General Manager
Research & Development**



Ramprasadh

**Assistant General Manager
Sales & Marketing**



Sampathkumar

Assistant General Manager - Legal



Felix anand

Assistant General Manager - HRD

Accomplishment



2010 - Company Incorporation



2011 - Started Manufacturing Solar Water Heater



2012 - Started Manufacturing Solar Street Light



2013 - Started Manufacturing Solar Off Grid Power



2014 - Added Solar Water Pump Manufacturing



2015 - Started our PV Modules Manufacturing Unit



2016 - Successfully launched our first Government Tender Projects



2017 - Solar Integrated for Solar on grid Power Plant



2018 - Started our solar services for other brands under AMC

Accomplishment



2019,2020 - Successfully implemented a rooftop megawatt project



2021 - Started Ground Mounted Megawatt Projects



2022 - Successfully Commissioned our first Ground Mounted Project



2023 - Successfully Installed 10 Megawatt Projects.



2024 - Successfully reached 50 Megawatts (34 MW Ground Mounted, 16 MW Rooftop).



2025 - Successfully Completed 80 Megawatt Projects and come up with Battery Energy Storage System (BESS)



2026 - Started Manufacturing Battery Energy Storage System and come up with Windmill.

Our Foot Print



500+
Project's Done



430+
Happy Client's

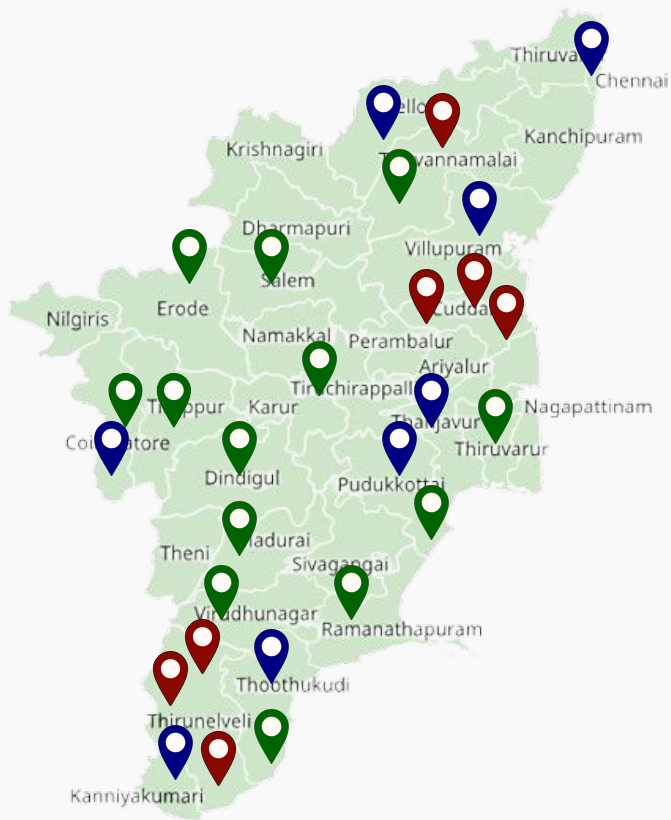

20+
Awards Winning



100%
Service Quality

 Ground Mounted Projects - 60 MW

 Rooftop Solar Projects - 20 MW

 PM - Ghar Yojana Scheme

Our Achievements

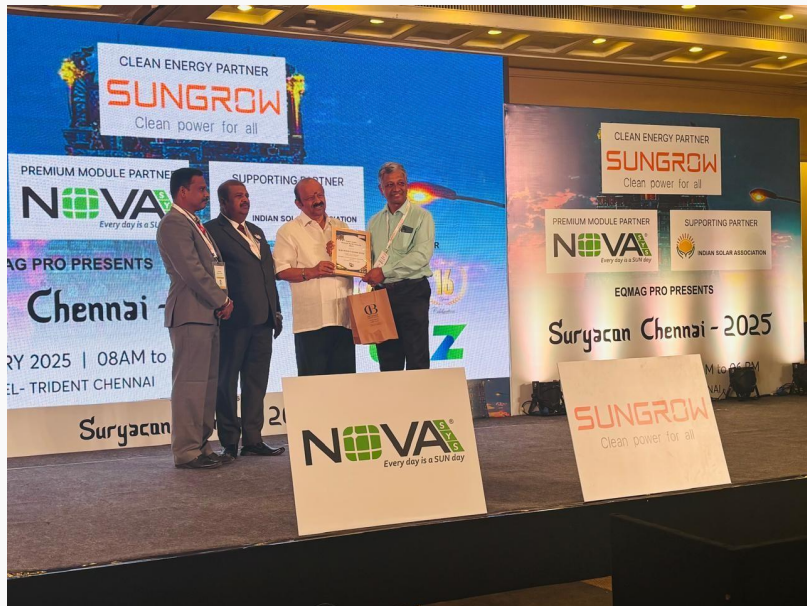

Our Achievements



We are members in this Association



1. **ITAMMA**- Indian Textile Accessories and Machinery Manufacturers Association.

2. **CODISSIA** - Coimbatore District Small Industries Association.

3. **TAI**- Textile Association (India).

4. **SIMA** - Southern India Mills Association.



Our Service

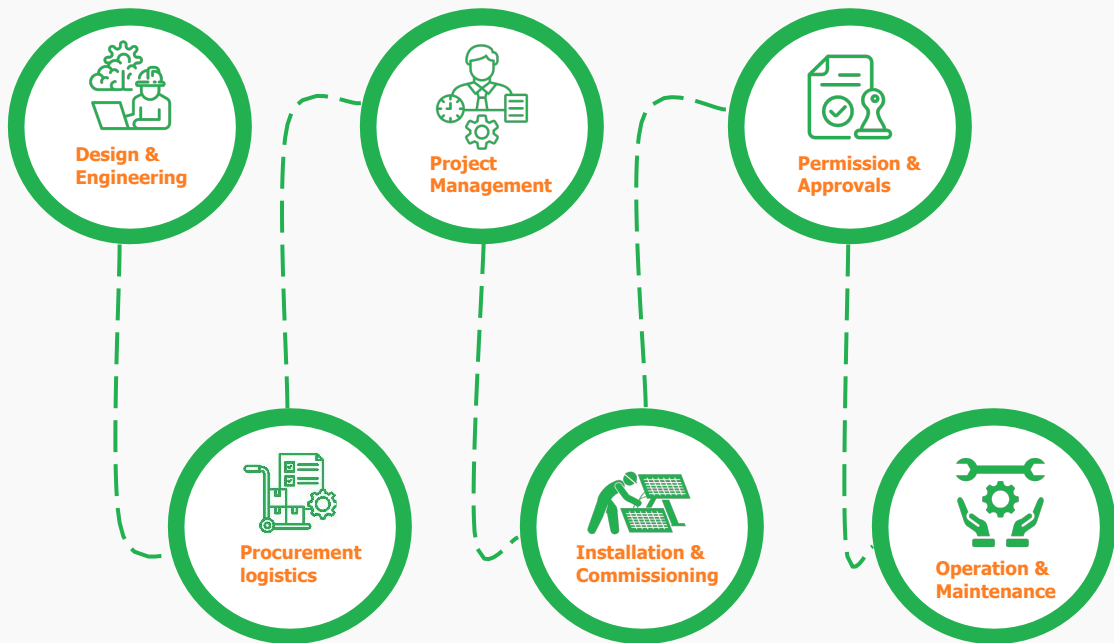

Services



Ground Mounted Solar



Rooftop Solar



PM Scheme - Ghar Yojana



Battery Energy Storage Systems

Types Of Solar System

Off - Grid Systems- With Battery backup



**On – Grid Systems- No battery backup.
Export facility available**



MW Ground Mounted Projects

Benefits:

A Ground Mounted solar system is a solar panels are mounted on a structure directly anchored to the ground, allowing for large scale solar power generation compared to rooftop systems, by utilizing open spaces with optimal sun exposure to maximize energy production; key elements include site selection, soil analysis, mounting structures, panel arrangement, wiring inverters, and considerations for land preparation, permitting, and maintenance to ensure efficient operation and minimize environmental impact.

Larger capacity : Can be built on a larger scale to meet high energy demands for residential, commercial, or utility- scale projects.

Easy Installation : Generally easier to install compared to rooftop systems as it does not require roof structural assessments.

Inverter : Solar PV Inverter Grid - tie inverters convert DC electrical power into AC power suitable for injecting into the electric utility company grid.

Mounting structure : The structures has been designed for 140 km/Hr wind speed and will be made up of hot dip galvanized mild steel of suitable size and designed to withstand forces during normal conditions and abnormal conditions.

Ground Mounted Solar

The Chennai Silks Groups



Capacity - 14.6 MW

Sulur Maharaja, Coimbatore



Capacity - 7.8 MW

Ground Mounted Solar

Sri Vasudeva Textiles (P) Ltd , Coimbatore



Capacity - 7 MW

Saravana Stores, Chennai



Capacity - 5.2 MW

Ground Mounted Solar

NISO Solar Energy Pvt Ltd, Tiruppur



Capacity - 10.4 MW

Suruchi Refinery Pvt Ltd, Coimbatore



Capacity - 2.6 MW

Ground Mounted Solar

Swathi Cottfab Exports, Annur



Capacity - 2.6 MW

JBSQA Solar Power (P) Ltd, Qatar



Capacity - 2.6 MW

Ground Mounted Solar

Subadra Spinning Mills, Tiruvannamalai



Capacity - 1MW

Sri Ranga Textiles Pvt Ltd,
Aruppukottai



Capacity - 1.3 MW

Ground Mounted Solar Project Videos



Megawatt Project Video - The Chennai Silks

Megawatt Project Video - Sulur Maharaja

MASTrack Scada



MASTrack SCADA

Centralized Remote Monitoring of Power plants through IoT and Cloud based data access Innovative and user-friendly **SCADA** software to monitor Daily Energy generation, Total Energy Generation, Revenue Generation, Plant CUF, Plant Specific Yield, Power, Voltage, Current, Power factor, Frequency in Day, Week, Month and Year wise. To ease the Maintenance activities the Inverter Fault status, SMB and String fault status helps in faster troubleshooting and reduced down time resulting in higher energy production.

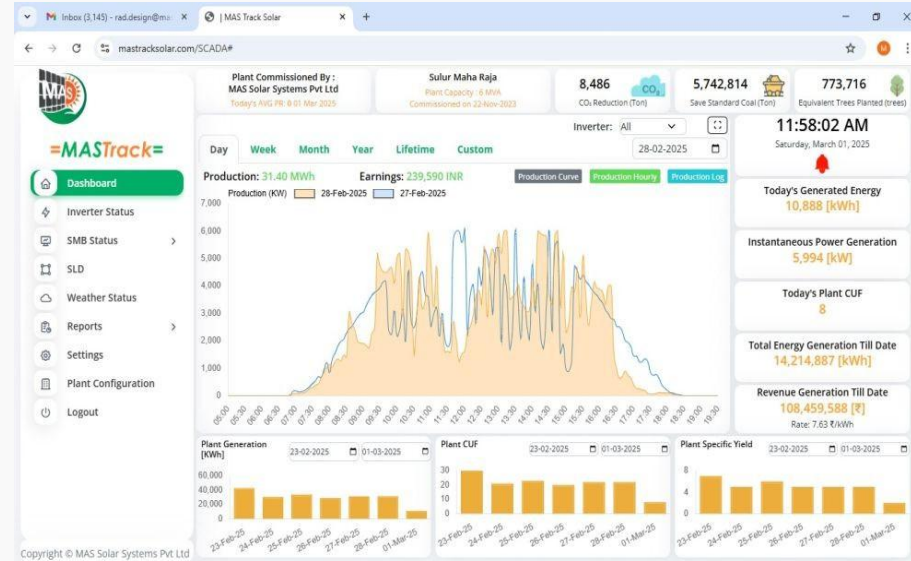

MASClean Robot

PV Module Cleaning Robot

MASClean PV Module Cleaning Robot

The **MAS Solar Systems** Cleaning Robot is a user-friendly and advanced tool designed to clean solar panels, ensuring optimal energy production and efficiency. It offers cost savings, is easy to use, and can extend the lifespan of solar panels. It is a valuable investment for both residential and commercial solar system owners, as it maximizes energy production, avoids professional cleaning service, and ensures long-term performance.



Introduction of

Battery Energy Storage Systems



MAS Solar

MAS SOLAR is a forward-thinking energy solutions company focused on delivering advanced **Battery Energy Storage Systems (BESS)** for industrial, commercial, and renewable power applications. Our BESS solutions are designed to enhance energy reliability, optimize power usage, and support sustainable growth for modern businesses.

With strong technical expertise and a commitment to innovation, Mohana RenewCare provides end-to-end BESS services including system design, integration, installation, monitoring, and long-term maintenance. Our storage systems ensure seamless backup power, peak-load management, and efficient utilization of solar energy.

We aim to empower organizations with smart, scalable, and cost-effective energy storage technologies that accelerate the transition toward clean and resilient power infrastructure.

Utility Scale



Energy Arbitrage, Resource Adequacy, Frequency Regulation

Commercial & Industrial

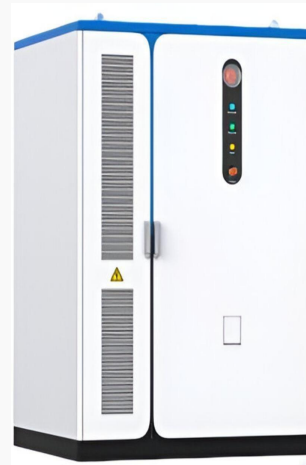

Demand charge reduction, backup power, process stability, and renewable integration.

Residential

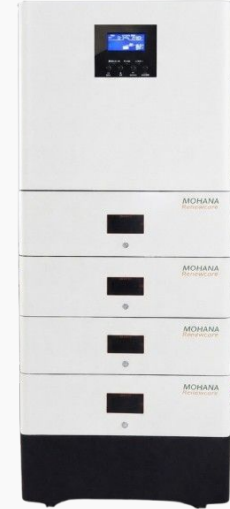

Energy backup, Self-Consumption of Solar Energy.

Battery Energy Storage Systems

Our Products :

- 1.25 MW / 5.016 MWh BESS
- 1 MW / 2.612 MWh BESS
- 500 KW / 1.044 MWh BESS
- 250 KW / 522 KWh BESS
- 105 KW / 522 KWh BESS



Battery Energy Storage Systems

Utility Scale | Commercial & Industrial | Residential

Line Diagram : Solar & BESS Integration

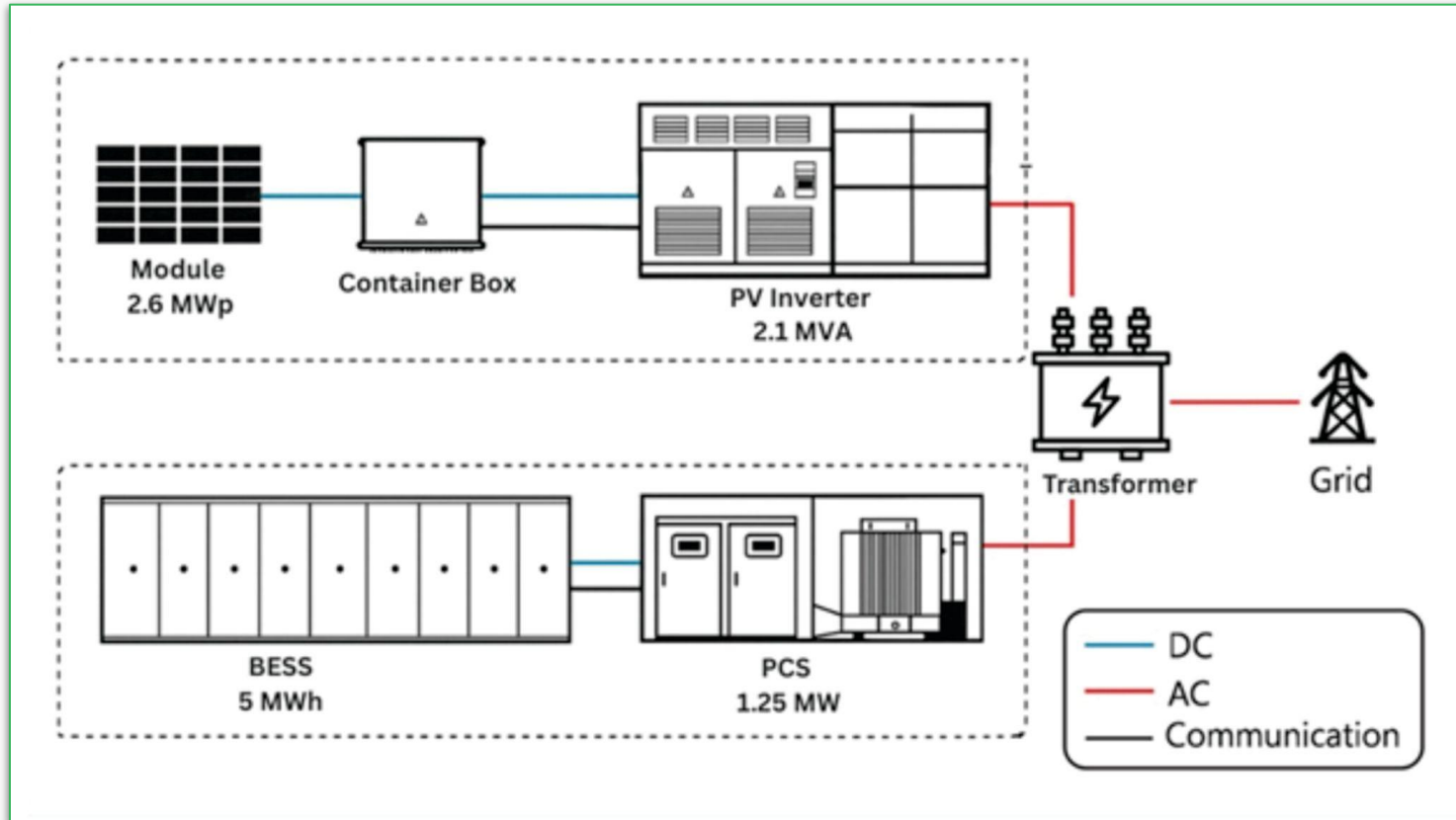

Solar Plant BESS Integration



Rooftop Solar

CNV Textile Private Limited - Coimbatore



Capacity - 685 KW

SITRA - Coimbatore



Capacity - 130 KW

Rooftop Solar

Padma Textiles - Coimbatore



Capacity - 100 KW

Sri Amman Spinners - Tirupur



Capacity - 130 KW

Rooftop Solar

Suba Textiles - Tirupur



Capacity - 80 KW

Usha Textiles - Tirupur



Capacity - 99 KW

PM Scheme

Ghar Yojana



Capacity - 6 KW



Capacity - 6 KW



Capacity - 4 KW



Address



**MAS Solar Systems Limited
MAS Solar EPC Private Limited
153, SIDCO Industrial Estate,
Malumichampatti Coimbatore, Tamil
Nadu 641050.**

Contact Us



**9585556502
9585556504**



**marketing@massolarsystems.com
m1@massolarsystems.com**

 **Our Website : www.massolarsystems.com**



Thank
You