



MAS Solar

Switch To Green Energy

Company

Introduction



MAS Solar Systems Limited was established in AUGUST 2010 in the well-equipped Industrial Estate in Coimbatore which is Manchester of South India. MAS Solar Systems Limited started to focus completely on Solar Energy and its applications.

MAS Solar Systems Limited is one of the Solar PV Modules Manufacturers in India. We provide solutions for power related to various Industries, Institutions, Domestic & Commercial purpose. We also tie- up with Renewable Research Institutions & Industries for Product development, Testing & Certifications, Training and Awareness program.

MAS Solar Systems Limited has gained a well revered name in the domain of solar equipments. We are one of the leading manufacturer, supplier of hi-tech solar products in the market with the strong Research & Development team. The company has planned to introduce various solar products to the nation in “motto to support use of solar energy” by giving the quality solar products. The company MAS was incorporated in the year 2010 at Coimbatore.

Our Vision, Mission, Goal



Vision

Deliver renewable energy solutions that delight customers and create shareholder value.



Mission

Become a world class solar energy manufacturer and solutions provider with affordable prices globally



Goal

Aim to lead the solar power industry and achieve ₹10000 crore turnovers with 500 happy employees and 500 satisfied Customers by 2030

Director

Keynote



Since inception from the year 2010 MAS Solar System is fully committed to emerge pioneer in solar products. We have seen very steady growth years except Covid 19 period and it reminds me that how we have maneuvered those situation to sustain our business .I am really proud to be having candid attitude employees, elite customers, noble supply partners and encouraging directors during difficult time. Currently we have expanded our business largely in Megawatt Ground Mounted portfolio to achieve our ambitious growth plan before the year 2025. With all your support and blessings of our esteemed customers, Mas Solar will achieve these target easily.

Anbazhagan. P
Managing Director

Board Of Director's



K. Suganthi
Whole Time Director



Dr. Visagamoorthy
Independent
Director



R. Vincent Jeyaraj
Independent
Director

Key Person's



Arjunan

Company Secretary



Senthilkumar

**Deputy General Manager
Research & Development**



Ramkumar

**Deputy General Manager
Sales & Marketing**



Ramprasadh

**Assistant General Manager
Sales & Marketing**



Sampathkumar

Assistant General Manager - Legal



Lakshmana

Chief Financial Officer



Felix anand

Assistant General Manager - HRD

Accomplishment



2010 - Company Incorporation



2011 - Started Manufacturing Solar Water Heater



2012 - Started Manufacturing Solar Street Light



2013 - Started Manufacturing Solar Off Grid Power



2014 - Added Solar Water Pump Manufacturing



2015 - Started our PV Modules Manufacturing Unit



2016 - Successfully launched our first Government Tender Projects



2017 - Solar Integrated for Solar on grid Power Plant



2018 - Started our solar services for other brands under AMC

Accomplishment



2019,2020 - Successfully implemented a rooftop megawatt project



2021 - Started Ground Mounted Megawatt Projects

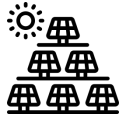

2022 - Successfully Commissioned our first Ground Mounted Project



2023 - Successfully Installed 10 Megawatt Projects.



2024 - Successfully reached 50 Megawatts (34 MW Ground Mounted, 16 MW Rooftop).



2025 - Successfully Completed 80 Megawatt Projects and come up with Battery Energy Storage System (BESS)

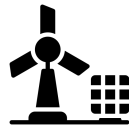

2026 - Started Manufacturing Battery Energy Storage System and come up with Windmill.

Announcement



We proud to Inform that, we have converted from Private Limited to Public Limited (MAS Solar Systems Limited) to expand our business to PAN India level with effect from And also ISO 9001:2015 certified company.

GOVERNMENT OF INDIA
MINISTRY OF CORPORATE AFFAIRS
 Central Processing Centre
 Plot No. 6,7, 8, Sector 5, IIT Manesar, Manesar, Haryana, India, 122050

Certificate of Incorporation Consequent upon conversion to public company

Corporate Identity Number: U4010RT22010PLC016269

IN THE MATTER OF MAS SOLAR SYSTEMS PRIVATE LIMITED

I hereby certify that MAS SOLAR SYSTEMS PRIVATE LIMITED which was originally incorporated on FIFTH day of AUGUST TWO THOUSAND TEN under Companies Act, 1956 as MAS SOLAR SYSTEMS PRIVATE LIMITED and upon an extension made for conversion into public company under Section 18 of the Companies Act, 2013 and approval of Central Government signified in writing having been accorded thereby by the ROC, CPC vide SPN AB4681 866 dated 17/06/2025 the name of the said company is this day changed to MAS SOLAR SYSTEMS LIMITED.

Given under my hand at ROC, CPC this EIGHTEENTH day of JUNE TWO THOUSAND TWENTY FIVE

Signature Not Verified
 Digitally signed by
 * nica.gov.in
 Date: 2025.06.19 15:12:18 IST

 Surinchi Motuja
 Assistant Registrar of Companies/ Deputy Registrar of Companies/ Registrar of Companies
 Central Processing Centre

Note: The corresponding form has been approved by Surinchi Motuja, Assistant Registrar of Companies/ Deputy Registrar of Companies/ Registrar of Companies and this letter has been digitally signed by the Registrar through a system generated digital signature under rule 8(1) of the Companies (Registration Officers and Fees) Rules, 2014

Mailing Address as per record available in Registrar of Companies office:
 MAS SOLAR SYSTEMS LIMITED
 SHED NO 153, SIDCO INDUSTRIAL ESTATE, MALLAMACHAMPATTI, NA, COIMBATORE, Coimbatore- 641050, Tamil Nadu



CERTIFICATE

The Certification Body
 of TÜV SÜD South Asia Private Limited
 certified that

MAS SOLAR SYSTEMS LIMITED
 Office: 142, SIDCO Industrial Estate, Mallamachampatti,
 Coimbatore - 641 050, Tamil Nadu, India
 including the sites and scope of application see enclosure

has implemented Quality Management System
 in accordance with **ISO 9001:2015**
 for the scope of

**Design, Development, Installation,
 Commissioning and Servicing of Solar PV Power Plant and
 Solar Products.**

The certificate is valid from **2025-06-10** until **2028-06-09**
 Subject to successful completion of annual surveillance audits.
 This certificate is a certification of the conformity of the system with the requirements of the standard ISO 9001:2015. The certificate is not a guarantee of the quality of the products or services provided by the certified organization.
 Certificate Registration No. **09 100 24937**
 Date of Initial certification: **2025-06-10**
 Issue Date: **2025-06-10** Rev. 00

 Head Office:
 TÜV SÜD CERTIFICATION (India) Private Limited
 142, SIDCO Industrial Estate, Mallamachampatti,
 Coimbatore - 641 050, Tamil Nadu, India
 Phone: +91 422 250 0000





QR CODE LINK: <https://www.tuv.com/india/0910024937>

ENCLOSURE OF CERTIFICATE
 Certificate Registration No.: **09 100 24937**

At the sites	scope
MAS SOLAR SYSTEMS PRIVATE LIMITED Office: 153, SIDCO Industrial Estate, Mallamachampatti, Coimbatore - 641 050, Tamil Nadu, India. MAS SOLAR EPC PRIVATE LIMITED (Design, Development, Installation, Commissioning and Servicing of Solar PV Power Plant and Solar Products)	Design, Development, Installation, Commissioning and Servicing of Solar PV Power Plant and Solar Products.
MAS SOLAR EPC PRIVATE LIMITED (Design, Development, Installation, Commissioning and Servicing of Solar PV Power Plant and Solar Products)	Manufacturing of Solar PV Modules and PV Solar Products.



 Head Office:
 TÜV SÜD CERTIFICATION (India) Private Limited
 142, SIDCO Industrial Estate, Mallamachampatti,
 Coimbatore - 641 050, Tamil Nadu, India
 Phone: +91 422 250 0000



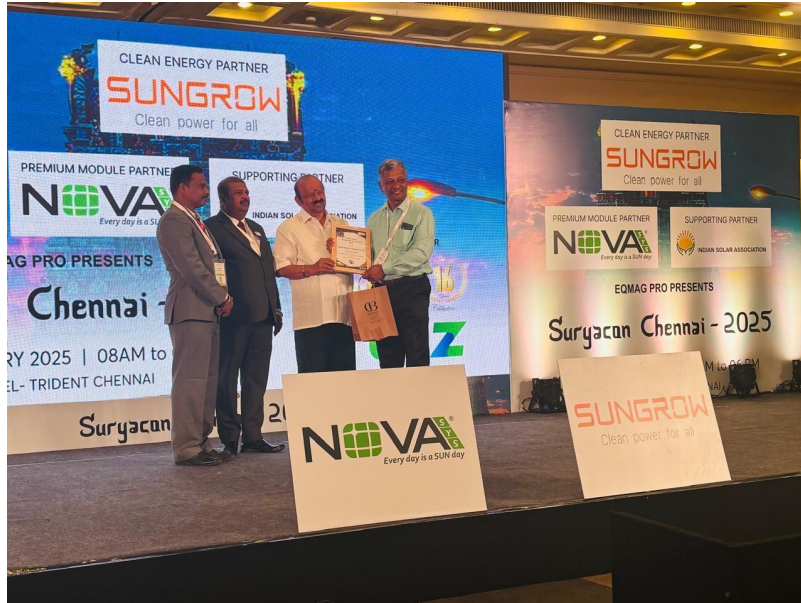

QR CODE LINK: <https://www.tuv.com/india/0910024937>

Our Achievements



Our Achievements



We are members in this Association



1. **ITAMMA**- Indian Textile Accessories and Machinery Manufacturers Association.
2. **CODISSIA** - Coimbatore District Small Industries Association.
3. **TAI**- Textile Association (India).
4. **SIMA** - Southern India Mills Association.



Our Service



Services



Ground Mounted Solar



Rooftop Solar



PM Scheme - Ghar Yojana



Battery Energy Storage Systems



Types Of Solar System



Off - Grid Systems- With Battery backup



**On – Grid Systems- No battery backup.
Export facility available**



MW Ground Mounted Projects



Benefits:

A Ground Mounted solar system is a solar panels are mounted on a structure directly anchored to the ground, allowing for large scale solar power generation compared to rooftop systems, by utilizing open spaces with optimal sun exposure to maximize energy production; key elements include site selection, soil analysis, mounting structures, panel arrangement, wiring inverters, and considerations for land preparation, permitting, and maintenance to ensure efficient operation and minimize environmental impact.

Larger capacity : Can be built on a larger scale to meet high energy demands for residential, commercial, or utility- scale projects.

Easy Installation : Generally easier to install compared to rooftop systems as it does not require roof structural assessments.

Inverter : Solar PV Inverter Grid - tie inverters convert DC electrical power into AC power suitable for injecting into the electric utility company grid.

Mounting structure : The structures has been designed for 140 km/Hr wind speed and will be made up of hot dip galvanized mild steel of suitable size and designed to withstand forces during normal conditions and abnormal conditions.

Ground Mounted Solar



The Chennai Silks Groups



Capacity - 14.6 MW

Sulur Maharaja, Coimbatore



Capacity - 7.8 MW

Ground Mounted Solar



Sri Vasudeva Textiles (P) Ltd , Coimbatore



Capacity - 7 MW

Saravana Stores, Chennai



Capacity - 5.2 MW

Ground Mounted Solar



NISO Solar Energy Pvt Ltd, Tiruppur



Capacity - 10.4 MW

Suruchi Refinery Pvt Ltd, Coimbatore



Capacity - 2.6 MW

Ground Mounted Solar



Swathi Cottfab Exports, Annur



Capacity - 2.6 MW

JBSQA Solar Power (P) Ltd, Qatar



Capacity - 2.6 MW

Ground Mounted Solar



Subadra Spinning Mills, Tiruvannamalai



Capacity - 1MW

Sri Ranga Textiles Pvt Ltd,
Aruppukottai



Capacity - 1.3 MW

Ground Mounted Solar Project Videos



Megawatt Project Video - The Chennai Silks

Megawatt Project Video - Sular Maharaja

Generation Report :



YEARLY GENERATION REPORT OF SULUR MAHARAJA SOLAR GREEN POWER - 6 MW AC AND 7.8 MW DC - Moolakaraipatti SS

FY 2023-24			FY 2024-25			FY 2025-26		
S.NO	MONTH	GENERATION DETAILS @ 7.2 MW DC	S.NO	MONTH	GENERATION DETAILS @ 7.8 MW DC	S.NO	MONTH	GENERATION DETAILS @ 7.8 MW DC
1	Dec-23	621271	1	Apr-24	1086888	1	Apr-25	979900
2	Jan-24	835616	2	May-24	905944	2	May-25	1039949
3	Feb-24	940526	3	Jun-24	1032018	TOTAL		2019849
4	Mar-24	1172450	4	Jul-24	988259	Per Day Generation		4316
TOTAL		3569863	5	Aug-24	1087566			
Per Day Generation		4132	6	Sep-24	1163027			
			7	Oct-24	923011			
			8	Nov-24	691493			
			9	Dec-24	857613			
			10	Jan-25	810127			
			11	Feb-25	999191			
			12	Mar-25	1033396			
			Total		11578533			
			Per Day Generation		4067			

MASTrack Scada



MASTrack SCADA

Centralized Remote Monitoring of Power plants through IoT and Cloud based data access Innovative and user-friendly **SCADA** software to monitor Daily Energy generation, Total Energy Generation, Revenue Generation, Plant CUF, Plant Specific Yield, Power, Voltage, Current, Power factor, Frequency in Day, Week, Month and Year wise. To ease the Maintenance activities the Inverter Fault status, SMB and String fault status helps in faster troubleshooting and reduced down time resulting in higher energy production.

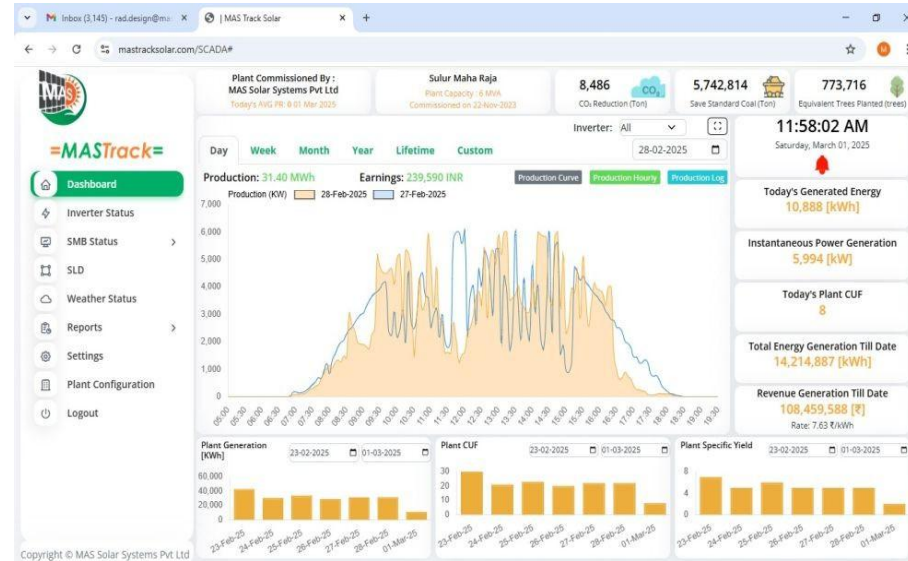

MASClean Robot PV Module Cleaning Robot

MASClean PV Module Cleaning Robot

The **MAS Solar Systems** Cleaning Robot is a user-friendly and advanced tool designed to clean solar panels, ensuring optimal energy production and efficiency. It offers cost savings, is easy to use, and can extend the lifespan of solar panels. It is a valuable investment for both residential and commercial solar system owners, as it maximizes energy production, avoids professional cleaning service, and ensures long-term performance.



[MASClean Robot Video](#)

Introduction of

Battery Energy Storage Systems



MAS SOLAR is a forward-thinking energy solutions company focused on delivering advanced **Battery Energy Storage Systems (BESS)** for industrial, commercial, and renewable power applications. Our BESS solutions are designed to enhance energy reliability, optimize power usage, and support sustainable growth for modern businesses.

With strong technical expertise and a commitment to innovation, Mohana RenewCare provides end-to-end BESS services including system design, integration, installation, monitoring, and long-term maintenance. Our storage systems ensure seamless backup power, peak-load management, and efficient utilization of solar energy.

We aim to empower organizations with smart, scalable, and cost-effective energy storage technologies that accelerate the transition toward clean and resilient power infrastructure.

Utility Scale



Energy Arbitrage, Resource Adequacy, Frequency Regulation

Commercial & Industrial



Demand charge reduction, backup power, process stability, and renewable integration.

Residential

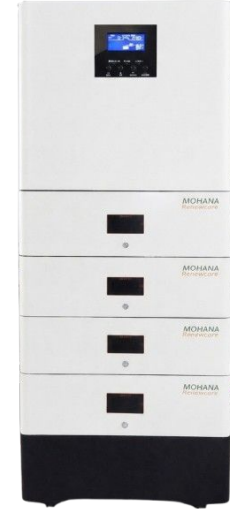

Energy backup, Self-Consumption of Solar Energy.

Battery Energy Storage Systems



Our Products :

- 1.25 MW / 5.016 MWh BESS
- 1 MW / 2.612 MWh BESS
- 500 KW / 1.044 MWh BESS
- 250 KW / 522 KWh BESS
- 105 KW / 522 KWh BESS



Battery Energy Storage Systems

Utility Scale | Commercial & Industrial | Residential

Line Diagram : Solar & BESS Integration

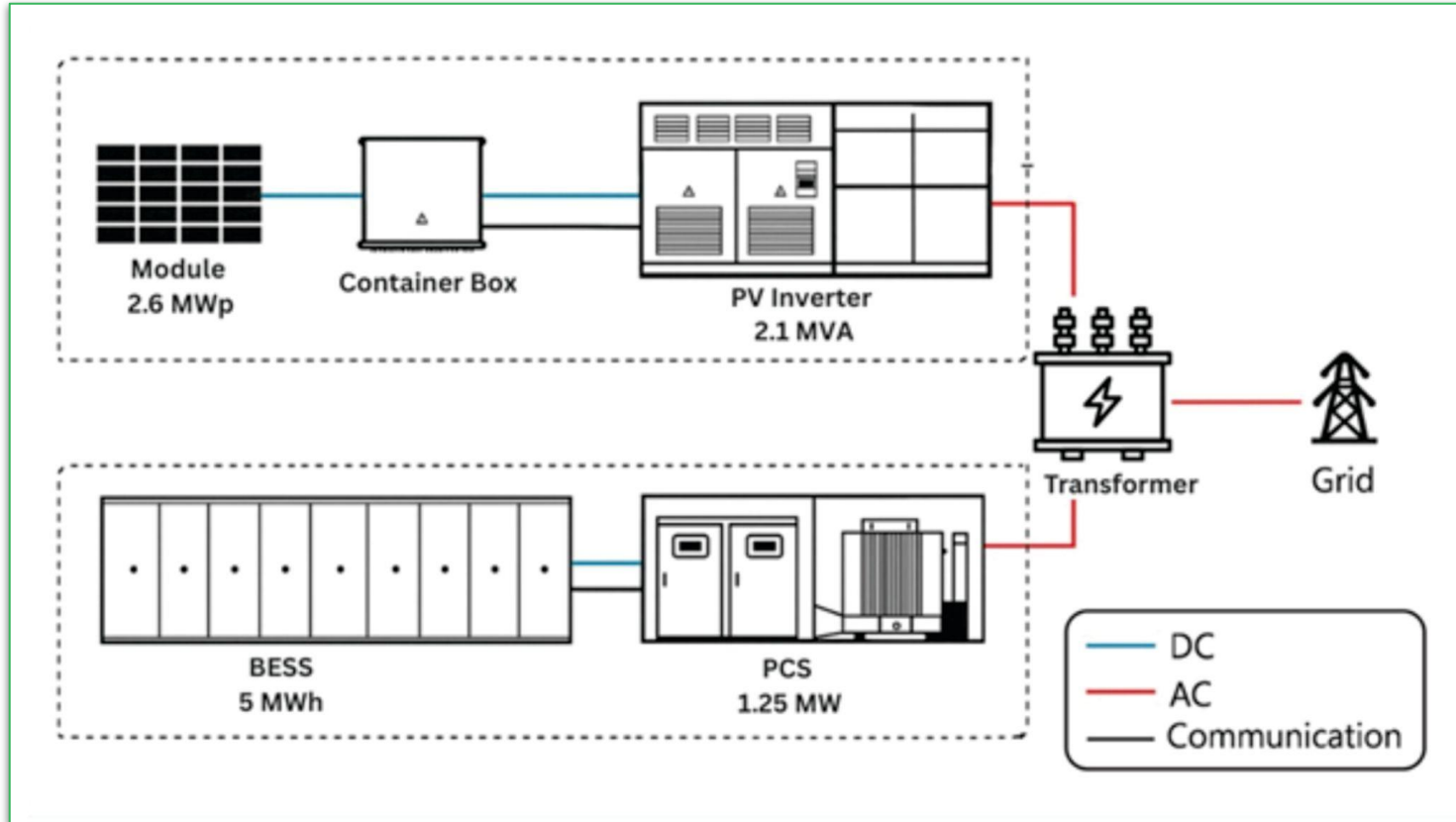

Solar Plant BESS Integration



Rooftop Solar



CNV Textile Private Limited - Coimbatore



Capacity - 685 KW

SITRA - Coimbatore



Capacity - 130 KW

Rooftop Solar



Padma Textiles - Coimbatore



Capacity - 100 KW

Sri Amman Spinners - Tirupur



Capacity - 130 KW

Rooftop Solar



Suba Textiles - Tirupur



Capacity - 80 KW

Usha Textiles - Tirupur



Capacity - 99 KW

PM Scheme

Ghar Yojana



Capacity - 6 KW



Capacity - 6 KW



Capacity - 4 KW



Address



**MAS Solar Systems Limited
MAS Solar EPC Private Limited
153, SIDCO Industrial Estate,
Malumichampatti Coimbatore, Tamil
Nadu 641050.**

Contact Us



**9585556502
9585556504**



**marketing@massolarsystems.com
m1@massolarsystems.com**

 **Our Website : www.massolarsystems.com**



Thank
You